

# Energy Savings through Site Renewal in an HSPA/LTE Network Evolution Scenario

Gilbert Micallef<sup>(1)</sup>

<sup>(1)</sup>Aalborg University,  
Aalborg, Denmark.

Preben Mogensen<sup>(1,2)</sup>,

<sup>(2)</sup>Nokia Siemens Networks,  
Aalborg, Denmark.

Hans-Otto Scheck<sup>(3)</sup>,

<sup>(3)</sup>Nokia Siemens Networks,  
Kista, Sweden

*Abstract – Mobile network operators are committing themselves to reduce the energy consumption of their networks. However, the expected growth in traffic and the upgrades required to sustain this growth pose a serious question on whether these targets are achievable. Through a case study, this paper looks at how the energy consumption of a mobile network is likely to develop over a period of nine years, considering the evolution of an existing HSPA layer into a multi-layered (HSPA+LTE) network. Besides, this study also considers four different equipment versions released throughout the years, which are introduced in the network based on a replacement strategy. In addition, the two most modern sites are assumed to be configured with remote radio head. In comparison to the reference case which leads to an increase in energy consumption of almost 200%, considering these site upgrades can limit the increase to just 12%. In some cases, when a less aggressive traffic growth is assumed, the energy savings are enough to balance any increase in energy. In a best case scenario, where all sites are replaced when new equipment is available, energy savings close to 40% are achievable.*

**Keywords-component; energy saving, network evolution, equipment replacement, remote radio head, base station site, HSPA, LTE, energy efficiency.**

## I. INTRODUCTION

After the burst of the communications bubble, many network operators were left stranded with newly deployed 3G networks that were in reality doing little more than their GSM counterpart. The uptake of mobile internet was mainly hindered by a combination of: steep pricing, low data rates (in comparison with fixed services), and the lack of devices for an adequate consumption of content, all leading to an overall poor user experience. This took a turn for the best with the upgrade of 3G networks to high speed packet access (HSPA), boosting downlink data rates (7 Mbps) [1] to values comparable with traditional fixed internet services. Around the same time Apple launched their first generation iPhone, reinventing the phone industry while setting new standards for multimedia content consumption and user experience. These factors together with: adequate flat-rate pricing, the phenomenon of social networks, and an increasing pool of dedicated content, started to load mobile networks. Since 2007, mobile data traffic has been year after year “nearly tripling” [2].

In some countries, this persistent growth has taken mobile network operators (MNOs) by surprise, with some networks having difficulty dealing with busy hour traffic. While MNOs and equipment vendors alike are busy investigating and implementing long term plans for upgrading existing networks, some operators have already started capping their flat-rate services [3]. This is being done in an attempt to prolong the capabilities of their existing infrastructure, prior to any upgrades.

For their existing HSPA network, operators can increase capacity by: deploying additional sites, enabling additional carriers (if available), higher order sectorization i.e. going to 6 sectors, capacity enhancing features such as MIMO, and the deployment of micro/pico sites for offloading traffic from neighbouring macro sites. While these upgrades can initially sustain the expected growth, it has become inevitable that network operators will in the coming years also have to deploy an additional network layer (Long Term Evolution – LTE).

Most techniques and options used to increase the capacity of the network require additional equipment and/or changes in parameters, increasing the energy consumption of the sites and hence the network. Following this assumption, the overall energy consumption trend of mobile networks can be expected to continue increasing with increasing traffic. MNOs are however seeking possible options for actually *reducing* the energy consumption of their networks, with special focus being put on the energy consumption of base station sites, which are responsible for a hefty portion of the overall network operations [4]. Besides the obvious benefits of a reduction in energy related operational costs, MNOs are also aware of the positive impact of portraying themselves as an environmentally conscious operator. In fact, a number of operators, such as [5], have on the Corporate Social Responsibility (CSR) pages of their websites committing themselves to reduce the energy consumption of their operations by a specific amount (15%) and within a particular timeframe (2006-2020). Other operators are even more optimistic with [6] and [7] aiming to reduce their energy consumption by 40% and 50% respectively.

A previous study [8] has looked at the impact of different network capacity evolution strategies on the energy consumption and efficiency of existing mobile networks. For this reason, the main focus has been existing HSPA networks, with results showing, that the deployment of pico sites together with fewer macro upgrades is more energy efficient than macro only upgrades. Through the case study presented in this paper, [8] has been replicated and extended to also consider:

1. Deployment and upgrading of an LTE network layer.
2. Modernization of base station sites with the replacement of legacy base station site equipment and the upgrade of new sites to remote radio head (RRH) configuration.

This network evolution is carried out over a period of 9 years (2010-2018) with the overall objective being that of estimating how the energy consumption and efficiency trends of mobile networks are expected to develop with traffic, and how likely MNOs are to achieving their energy saving targets.

## II. BASE STATION SITE ENERGY CONSUMPTION

Base station sites, play a crucial role in providing the wireless link between the mobile user and the network. These sites are dotted over a national region, with the coverage area of each site ranging from a few hundred meters in urban areas, to a few kilometers in rural areas. Base station sites contain a variety of equipment that all together provide a continuous and reliable communication node, which also allows for the operator to remotely monitor, manage, and optimize the site. Figure 1 presents a simple overview of some of the key components within a macro base station site, also highlighting the ones which are primarily considered for the energy modeling throughout the study. Since the RF module houses the power amplifiers this makes it one of the main energy consumers within a base station site. The system module provides all functionalities for baseband processing, control, and transmission.

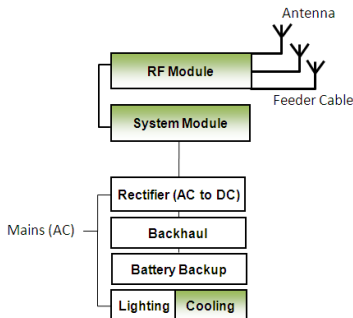

Figure 1 – Modular overview of some of the main components in a typical macro base station.

Since the first generation (or version) of base station equipment, a number of additional performance requirements and technological advancements have allowed for a wide range of improvements, making the new equipment more operationally flexible, compact, and scalable to handle future upgrades and features. A site can also house multiple base stations for different standards and other telecom equipment utilizing the same site support equipment.

## III. INTRODUCTION TO THE CASE STUDY

The network evolution analysis presented in this study is based on a case study, considering a section of the network in a dense urban area of a major European operator. This allows for network related information such as base station site location and configuration parameters to be taken directly from the network, enabling a more realistic simulation scenario. In addition, traffic statistics on an hourly resolution from the same sites over a number of weekdays allows for a better understanding of how much traffic is currently generated, when, and how this is distributed over the area.

### A. Traffic Modeling

Since the paper is based on the evolution of mobile networks over a period of years, the existing traffic carried by the network has to be appropriately increased and extended over this period. The overall increase in traffic is expected as a result of an increase in: the number of mobile broadband subscriptions and in the amount of data consumed by each subscriber. Traf-

fic growth forecast modeling is based on a number of different inputs, including: Cisco’s Visual Network Index Report [2], and predictions from the network operator and equipment vendor in question. This modeling leads to an average yearly increase in traffic of about 70%, which over the period considered leads to a traffic growth by a factor of x75. Since this can be considered as a rather aggressive growth, a second traffic growth rate (with an average of 55% per year) is considered for comparison, leading to a total traffic growth by a factor of x30. Since the study is based on multiple network layers, traffic is also split between the HSPA and LTE layers. The LTE layer is assumed to be deployed in late 2011; however, limited by the expected slow penetration of LTE-enabled devices in the first years, HSPA is expected, up until 2016, to remain the layer carrying most of the traffic. This highlights the importance of maintaining and upgrading the existing HSPA network. Figure 2 presents the aggressive traffic growth and how this is split between the HSPA and LTE layers.

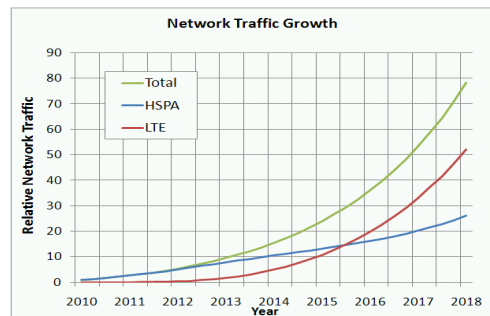

Figure 2 – Predicted traffic growth at an average rate of 70% per annum, representing the aggressive traffic growth rate. The figure also shows how the traffic is divided between the two network layers.

### B. Network Capacity Evolution

In order for the network to handle this increase in traffic without affecting the perceived user performance, a number of capacity upgrades on both network layers are required. In a previous study [8] two main evolution paths have been investigated with the conclusions of the study being that a joint macro upgrade and pico deployment solution is more energy efficient than a macro-only alternative. For this reason, this paper focuses on upgrading (when necessary) both network layers with a combination of 6 sector upgrades and the deployment of pico sites. All upgrades are driven by the need for the network to ensure a predefined level of network performance.

### C. Equipment Evolution

Energy results obtained in [8] are based on the assumption that all base station sites are composed of the same version of equipment. This means that a macro base station site in 2010 and another in 2018 are assumed to consume the same amount of energy. However, continuous improvements in the technology have allowed for equipment vendors to pack additional features in their products. Since a substantial percentage (>80%) of the energy consumption incurred by MNOs occur at base station sites [4][6], the need for reduced energy costs and an ‘environmentally conscious’ label have pushed equipment vendors to also compete by including features and improvements that are specifically aimed at addressing this issue.

Figure 3 provides an overview of how the energy consumption of base station equipment has developed and is expected to continue doing so in the next few years. It also shows that after some considerable improvements (2004-2008), mainly in power amplifier architectures, hardware related reductions in energy consumption have started and are expected to come at slower rates. While equipment that is available or expected on the market dictates what is achievable, it is important to note that for a MNO, the actual energy consumption is based on: when the sites are installed and/or updated, and what equipment versions were available and selected at the time. This means that most MNOs are likely to be running networks that are based on a mixture of equipment versions. In this case study, four different equipment releases are assumed, three from the past and one expected to be launched in 2013.

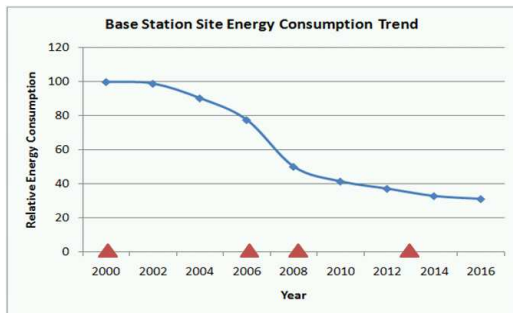

Figure 3 – Improvements in the energy consumption of different versions of base station equipment (assuming same configuration and operation). Markers identify the years of the releases assumed in this study.

#### IV. SIMULATION SETUP

This study is based on iterative montecarlo system level simulations. The location and orientation of each site together with the respective antenna patterns are imported directly from the network data. From the available traffic statistics, a density map is generated, which is then used to distribute users in areas of the network where traffic is generated. Based on the traffic model, for each specific year, a number of users are added to the network area, split in a predefined ratio between HSPA and LTE users (when applicable). Similar to [8], a link budget calculation is carried out from each cell to each user. The COST-Hata propagation model, fine tuned in relation to some network measurements, together with a digital elevation, and clutter maps are used for estimating the path loss. Knowing the transmission power at the base station sites, this allows for the received signal strength to be calculated. The cell from which the user experiences the strongest signal is selected as the serving cell, with all other signals adding up as interferes. This allows for the signal-to-interference plus noise ratio (SINR) of each user to be calculated. Depending on the considered technology, a mapping curve is used to translate SINR values into achievable data rate. These mapping curves are obtained from a combination of detailed link level simulations and actual measurements.

##### A. Key Performance Indicators

The performance of the network is measured in percentage of user satisfaction. At the beginning of each simulation, users are assigned a predefined minimum requested data rate. In order for users to achieve 'satisfaction', the network must as-

sign a data rate that is greater than or at least equal to this value. When more users are added to the network and the percentage of user satisfaction falls below the required level of 95%, this triggers available capacity upgrades (if any). In an attempt to restore the level of satisfaction, these upgrades are carried out in areas experiencing high traffic, ensuring more users achieve their minimum data rate.

In the case of multiple users within a specific cell, available resources must be shared and assigned in a way that maximizes user satisfaction. In the simulation tool, resources are distributed as follows. All users within a cell are sorted in accordance to their SINR values. Users with high SINR values require fewer resources to achieve their minimum requested data rate. By first assigning resources to these users, this maximizes the percentage of satisfied users. Since simulations assume a full load scenario, after assigning the minimum data rate to each user, any remaining resources are shared amongst all users in a round robin fashion, enhancing their data rate further.

##### B. Energy Calculations

The energy consumption of the network is calculated by summing up the energy consumption of each base station site. At each site the consumption is based on: the type of site (macro vs. pico), the configuration (3 sector vs. 6 sectors, no. of carriers, etc.), and the specific technology (HSPA, LTE, or both). The energy model used in the previous study [8] (based on 2008 release equipment) is generalized in such a way that it can allow for additional parameters and configurations to be define. When considering LTE sites, since a 2x2 MIMO configuration is assumed, an additional factor is assumed on top of the regular energy consumption. While this is specific for the equipment version being considered, this factor for the different equipment versions ranges between 75-80%. When upgrading sites to 6 sectors, the energy consumption is assumed to increase by a factor of 2. This is mainly based on the fact that for the added sectors, a second RF module is required. In addition to this an upgrade in the system module is also likely to be required for handling the added capacity.

Besides the energy consumption of the network, available simulation statistics also provide enough information to estimate the energy efficiency. This is measured as the amount of energy that is required to transfer a unit of data and is measured in kilo-watt-hour per terabyte (kWh/Tb). Since a full load scenario is assumed, the volume of data carried by the network during the busy hour is calculated. Since the energy consumption of the network during the same period is known, these two values can be used for understanding how the energy efficiency of the network develops. To note that a decreasing trend is equivalent to an improvement in the energy efficiency of the network since less energy is required to transfer the same volume of traffic.

##### C. Equipment Replacement

From the network data provided it is also possible to determine the version of the equipment at each base station site for the year 2010. The data shows that the considered sites are practically split between the first (release: 2000) and second (release: 2006) version of the equipment. The first is highly energy inefficient and in many cases requires active cooling to

maintain its operating temperature. Active cooling is in this case assumed to increase the energy consumption of the site by 30%. As a starting point it is assumed that none of the sites are equipped with remote radio head (RRH). RRH allows for the power amplifiers (PA) to be placed closer to the antenna, reducing feeder losses. This allows for a lower output power (at the PA) for achieving the same transmission power at the antenna. During the evolution, all sites upgraded to the existing (release: 2008) or future (release: 2013) equipment version are assumed to be equipped with RRH.

Along the years it is assumed that the original site equipment setup is upgraded and in some cases replaced with more efficient versions. Priority is given to phasing out the first version equipment, which consumes considerably more energy. When new sites are deployed, such as in for LTE (2011), it is assumed that the latest equipment version available is used. In the equipment replacement strategy, this study assumes a cost constraint which limits the number of sites that can be replaced. A best case scenario is also considered and presented later to allow some comparison. The energy trend of the network is measured by comparing the difference in energy consumption (considering all network layers) between the first and the last year of the evolution period. The case when all sites are assumed to be composed of the same equipment version (release: 2008) is used as a reference for comparison.

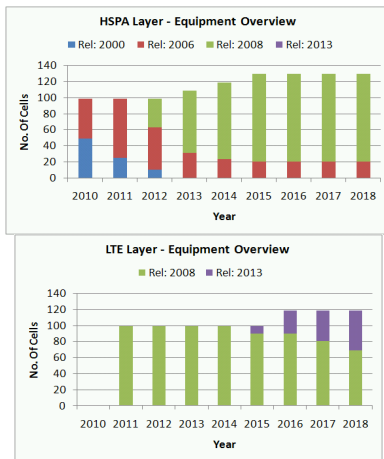

Figure 4 – A comparison to show which equipment is used for the different layers of the network. It is possible to note that most of the replacement is carried on the HSPA layer (early years), removing less efficient equipment.

In order to estimate the maximum energy savings possible through site replacement and upgrade to RRH, traffic is assumed to remain constant (2010 values) throughout the period, avoiding the need for capacity upgrades and LTE. By replacing the existing equipment with the 2013 version, this leads to a considerable reduction in energy consumption of 70%.

## V. RESULTS

### A. Network Capacity

Given the modeled increase in data traffic, a number of upgrades are required for ensuring that the network can sustain the required level of user satisfaction. In the case of a  $\times 75$  increase in traffic, the network requires that on both layers,

some sites are upgraded to 6 sectors and a number of outdoor pico sites are deployed. In the case with a less aggressive increase in traffic, the deployment of pico sites is enough to ensure that the network (both layers) reaches its performance targets. The number and type of upgrades performed are summarized in Table 1. These upgrades have an impact in how the energy consumption of the network evolves.

Av. Yearly Traffic Growth	Traffic Growth (2010-18)	HSPA Upgrades (2018)	LTE Upgrades (2018)
70%	$\times 75$	7x 6-Sectors + 30x Pico	10x 6-Sector + 20x Pico
55%	$\times 30$	5x Pico	20x Pico

Table 1 – Shows the extent of different upgrades performed for on the two network layers for sustaining the assumed traffic growth.

### B. Energy Trends- Aggressive Traffic Growth Forecast ( $\times 75$ )

In the reference case, when the same equipment version is considered, the energy consumption is noted to increase with every network upgrade. After performing all of the required upgrades, the energy consumption of the network is noted to increase by 198%, practically a factor of 3. Since the network is actually composed of older equipment, until replaced, these increase the energy consumption of the network. As newer sites are introduced, having RRH allows for further reductions in energy consumption. By considering that future upgrades are carried out with the expected equipment, the increase incurred by these upgrades is limited when compared to the original reference case. From an original +198%, the inclusion of equipment replacement and upgrade to RRH limits the increase in consumption to 12%. (Figure 5)

By looking at the separate trends of HSPA and LTE, it can be noted that most of the gains come from the HSPA layer since this is the layer where most site replacements are carried out. In addition if the deployment of LTE is delayed up until 2013, when the new equipment version is available, this is enough to balance out the trend, resulting in an energy status quo. This means that the network has been evolved in a way to carry  $\times 75$  more traffic, while consuming the same amount of energy.

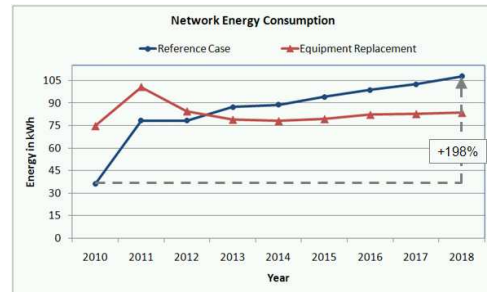

Figure 5 – An overview of how the energy consumption develops for the two cases. This graph is represents the case with an aggressive traffic growth.

This gain is clear when looking at the energy efficiency. Since upgrades are carried out with more energy efficient equipment, this improves the overall energy efficiency, reducing the amount of energy required to carry the same volume of traffic. Throughout the evolution period, even when considering the reference case, the energy efficiency of the network is noted to improve (Figure 6). This is because all capacity up-

grades are carried out in traffic hot-spots areas, increasing the volume of traffic carried. In the reference case, the amount of energy required to transfer the same unit of data is noted to reduce by a considerable 63%. Since in the early years the actual energy consumption of the network is higher than in the reference case, this reduces the efficiency of the network even further, improving the gains over the entire period to 87%.

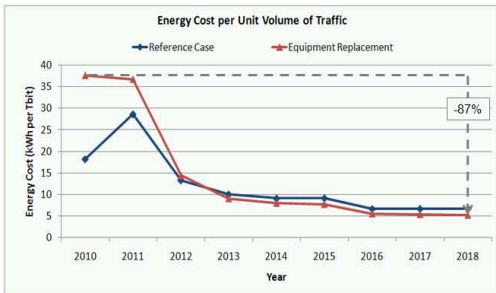

Figure 6 – How the energy efficiency of the network evolves. In the reference case, the first year is optimistic since it assumes more efficient equipment.

### C. Energy Trends- Mild Traffic Growth Forecast (x30)

In this case, considerably less upgrades are required, meaning that during the evolution period, the energy consumption of the network can be expected to increase less than when compared to the case with aggressive traffic forecast. In the reference case, the energy consumption is noted to increase by 132%. The same criteria are used for replacing equipment and upgrading to RRH. Different from the aggressive traffic growth case, comparing the last year with the first, this case shows a slight reduction (3%) in the energy consumption. By taking the same

By taking the same assumption of delaying the deployment of LTE up until 2013 this results in an overall reduction in energy consumption of 21%. While, this value is comparable with some of the targets that MNOs are setting, delaying the deployment of LTE is also likely to have an impact on the performance of the network. As expected, the energy efficiency trend is noted to be very similar in shape and values to that previously obtained in the aggressive traffic growth case. This is because network upgrades are always carried out in traffic hotspots, increasing the capacity by more than the energy is increased.

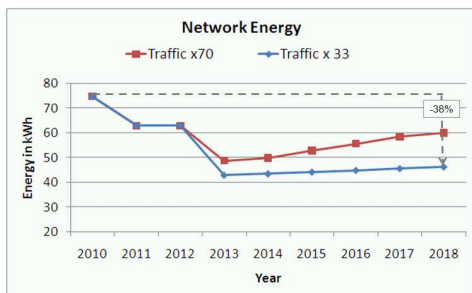

Figure 7 – Overview of the energy trend for both traffic growth cases while assuming a full equipment replacement strategy (best case scenario)

### D. Best Case Scenario – Full Replacement of Equipment

In this scenario, starting from the year 2011, all sites are replaced with the new equipment as soon as this is made available. While this is an unlikely scenario due to the involved costs

of replacing all sites, this can provide an estimate to the maximum energy saving possible. The results for both traffic cases are presented in Figure 7. The first noticeable difference from the previous energy trend is the fact that by replacing all HSPA equipment in 2011, this reduces the energy consumption of the network by so much, that even with the deployment of LTE, the overall energy consumption is less than in the first year. This highlights the energy inefficiency of older base station equipment. The results (Table 2) are presented and compared in the Table 2. Results in this scenario push towards reductions in energy consumption close to 40%.

Av. Yearly Traffic Growth	Traffic Growth (2010-18)	Energy Trend with Limited Replacement (2010-18)	Energy Trend with Full Replacement (2010-18)
70%	x75	+12%	-20%
55%	x30	-3%	-38%

Table 2 – Results comparing the energy trends between a limited replacement scenario, and a full replacement (best case) scenario. Results present the possible energy gains for both assumed network traffic growths.

## VI. CONCLUSIONS

Mobile network operators have the challenging task of upgrading the capacity of their networks, while at the same time reducing the energy consumption. Besides the upgrades required for providing additional capacity, this study looks at the possible energy gains through the replacement of base station equipment, and upgrade to RRH. Four different equipment versions are considered, with different sites being replaced throughout the investigated period. Given the assumption that traffic does not increase, and the existing HSPA network is upgraded to the most efficient equipment, a reduction in energy consumption of 70% can be achieved. However, when the required network capacity upgrades are considered, results show that a realistic site renewal strategy, leads to an *increase* in energy consumption of 12%. This is a considerable improvement in comparison to the previous +198% when a single equipment version (reference case) is considered. Assuming the same strategy, in the case with a milder traffic growth, the energy consumption is actually noted to decrease (3%), showing that energy savings are possible. While these figures are far from the targets set by network operators (15% - 50%), a best case scenario shows that these targets are in fact achievable, with results showing energy reductions close to 40%.

## REFERENCES

- [1] H. Holma, "HSDPA/HSUPA for UMTS: High Speed Radio Access for Mobile Communications", Wiley, 2006.
- [2] "CISCO Visual Network Index: Global Mobile Data Traffic Forecast Update, 2010-2015", White Paper, February 2011.
- [3] J. Halliday, C. Arthur, "Mobile Operators Signal End of Flat-Rate Data Tariffs as App Use Grows", www.guardian.co.uk, August 2010.
- [4] F. Richter, A. J. Fehske, G. P. Fettweis, "Energy Efficient Aspects of Base Station Deployment Strategies for Cellular Networks", IEEE Vehicular Technology Conference 2009, Anchorage, USA, September 2009.
- [5] Orange – "Towards a Greener World" [http://www.orange.com/en\\_EN/responsibility/environment/](http://www.orange.com/en_EN/responsibility/environment/) (visit: 28<sup>th</sup> April 2010)
- [6] Telenor – Operational Efficiency <http://www.telenor.com/en/corporate-responsibility/environment-and-climate/operational-efficiency/>
- [7] "Pressing Forward" – Vodafone Group Plc Sustainability Report, March 2010.
- [8] G. Micallef, P. Mogensen, H.O. Scheck, E. Lang, "Energy Efficient Evolution of Mobile Networks – Macro-Only Upgrades vs. a Joint-Pico Deployment Strategy", IEEE Vehicular Technology Conference 2011, Budapest, May 2011.