

I-Q Balancing Techniques for Broadband Receivers

fred harris
San Diego State University
fred.harris@sdsu.edu

Sinjeet Parekh
San Diego State University
parekh.@jason.sdsu.edu

Itzhak Gurantz
Entropic Corp.
igurantz@entropic.com

1. Abstract

Gain and Phase mismatch of the analog quadrature mixers in a modulator or demodulator is the cause of an undesired coupling of positive and negative frequency components of an up or down converted signal. This coupling is an interference that affects the detection performance of a communication system. It is necessary to suppress the mismatch in receivers that process signals spanning a wide range of signal levels as might be found when extracting one or more channels in multi-channel filter banks. This interference is removed by an adaptive process that cancels the cross coupled projections from the host signals.

2. Introduction

Gain and phase imbalance in the two paths of an analog I-Q processor cause undesired coupling between the positive and negative frequency components of the signal carried by the two paths. While all analog components in the two paths, such as filters and analog-to-digital converters (ADC), contribute to the mismatch, the largest contributor to the imbalance is the pair of (almost) matched balanced mixers. In the days of analog single sideband telephone systems the imbalance related interference was experienced as an annoying second audio signal in a subscriber's voice channel. In today's modulation schemes the interference limits the constellation density of a QAM system. This is quite evident in OFDM modulation in which the positive and negative frequency components of the FFT based demodulator talk to each other through the mismatch terms.

Controlling the mismatch is very important in receivers processing signals spanning a wide range of signal levels as might be found when extracting one or more channels in multi-channel filter banks. Many years ago, an RF engineer with whom we were working dismissed the idea of using DSP to undo the signal degradation caused by the analog I-Q imbalance terms arguing that the distortion was irreversible. He was wrong! Nearly every system we design contains an I-Q balancer. This paper presents a set of techniques to remove the distortion and discusses im-

portant system considerations that must be addressed in real systems.

Figure 1 presents the model of the gain and phase imbalance of an I-Q down converter. While it is common practice to split the gain and phase error terms between the two paths, we find this does little to enhance understanding of the problem so we elect to assign the error to only one of the two arms.

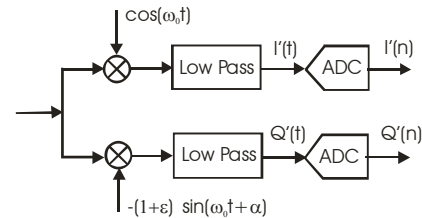

Figure 1. I-Q Mismatch in Quadrature Down Converter

Figure 2 presents the signal model illustrating the effect of the mismatch on the observed time domain signal. The observed quadrature terms I' and Q' are related to the desired quadrature terms I and Q by the relationship shown in (1). Also shown is the approximate inversion of this relationship that computes the desired terms from the observed terms.

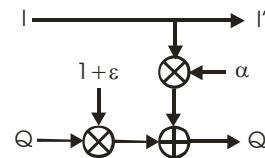

Figure 2. Time Domain Model of I-Q Mismatch

$$\begin{bmatrix} I' \\ Q' \end{bmatrix} = \begin{bmatrix} 1 & 0 \\ \alpha & 1+\epsilon \end{bmatrix} \begin{bmatrix} I \\ Q \end{bmatrix}, \quad \begin{bmatrix} I \\ Q \end{bmatrix} \cong \begin{bmatrix} 1 & 0 \\ -\alpha & 1-\epsilon \end{bmatrix} \begin{bmatrix} I' \\ Q' \end{bmatrix} \quad (1)$$

This approximate inverse reflects the signal processing tasks performed by the I-Q balancing system and shown in figure 3. The estimators for α and ϵ can be formed as

shown in (2) but are more likely estimated recursively with 1-tap gradient estimators of the form shown in (3).

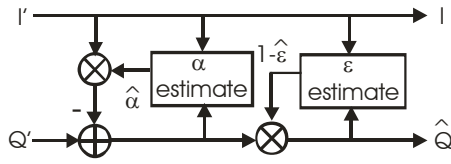

Figure 3. Model of I-Q Balancer

$$\begin{aligned} I' &= I \\ Q' &= Q(1 + \epsilon) + \alpha I \end{aligned} \quad (2)$$

$$E\{I' \cdot Q'\} = \alpha E\{I \cdot I\}; \quad \hat{\alpha} = \frac{E\{I' \cdot Q'\}}{E\{I \cdot I\}}$$

$$Q' - \hat{\alpha} I = Q(1 + \epsilon); \quad \frac{1}{(1 + \hat{\epsilon})} = \frac{E\{(Q' - \hat{\alpha} I)(Q' - \hat{\alpha} I)\}}{E\{I \cdot I\}}$$

$$\begin{aligned} e_1(n-1) &= [Q'(n-1) - \hat{\alpha}(n-1) \cdot I'(n-1)] \\ \hat{\alpha}(n) &= \hat{\alpha}(n-1) + \mu \cdot e_1(n-1) \cdot I'(n-1) \end{aligned}$$

(3)

$$\begin{aligned} Q''(n-1) &= |Q'(n-1) - \hat{\alpha}(n-1) \cdot I'(n-1)| \\ e_2(n-1) &= |Q''(n-1) \cdot \beta(n-1)| - |I'(n-1)| \\ [1 + \hat{\epsilon}(n)]^{-1} &= \hat{\beta}(n) = \hat{\beta}(n-1) + \mu \cdot e_2(n-1) \end{aligned}$$

Figure 4 shows a 16-QAM constellation with 0.1 gain and 0.1 radian imbalance and then the result of correcting the imbalance with an algorithm following the flow diagram of figure 3 and the gradient estimators of (3).

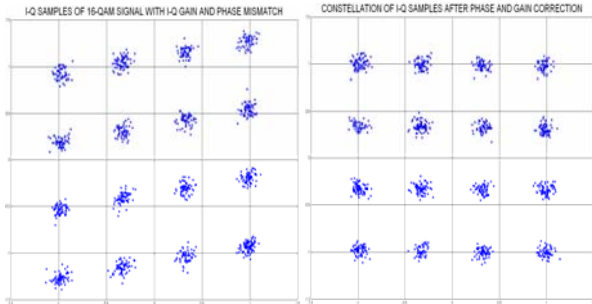

Figure 4. 16-QAM Constellation Before and After Correcting I-Q Imbalance

It is also useful to visualize the effect of I-Q mismatch in the frequency domain which is shown in figure 5 as the residual spectral terms resulting from the imperfect cancellation of the imbalanced Cosine and Sine terms. Here we see that the spectrum of the imbalanced quadrature sinusoid contains four spectral terms, the desired negative frequency term, an undesired positive frequency term

related to the gain imbalance ϵ , and a quadrature pair of terms related to the phase imbalance term α . The undesired terms contribute three interference terms to a base band down converted spectrum as is shown in (2).

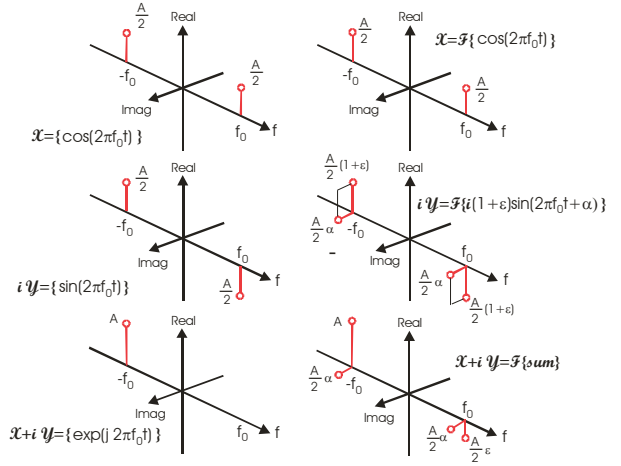

Figure 5. Spectra of Balanced and Unbalanced Quadrature Sinusoid

$$H'(\omega) = H(\omega) + 0.5\{H(\omega) \cdot (j\alpha) + H^*(\omega) \cdot (\epsilon + j\alpha)\} \quad (2)$$

3. Crosstalk between Channels

The I-Q imbalance example we examined in the previous section considered a single channel translated to base band by the quadrature down converter. The contamination we witnessed there is between the positive and negative frequency components of a single channel and the channel contains sufficient information to suppress the contamination. In another important scenario, a block converter down converts a set of channels to be separated by a set of subsequent second conversion processes. The crosstalk contamination between positive and negative frequencies is now between two channels. It is obvious the information required to suppress the contamination resides in the second channel. This condition is visualized in figure 6.

Figure 7 presents the signal model illustrating the crosstalk between two channels due to I-Q mismatch. These terms are the consequence of the extra spectral terms present in figure 5. The observed complex terms H'_1 and H'_2 are related to the desired complex terms H_1 and H_2 by the relationship shown in (4).

$$\begin{aligned} H'_1 &= H_1 + 0.5 \cdot (\epsilon + j\alpha) \cdot H_1 - 0.5 \cdot (\epsilon - j\alpha) \cdot H_2^* \\ H'_2 &= H_2 + 0.5 \cdot (\epsilon + j\alpha) \cdot H_2 - 0.5 \cdot (\epsilon - j\alpha) \cdot H_1^* \end{aligned} \quad (4)$$

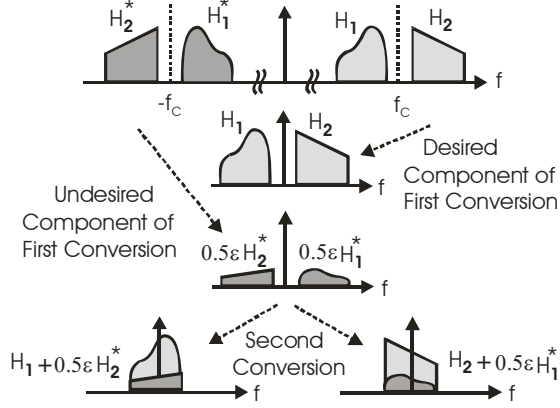

Figure 6. Spectral Crosstalk Between two Channels in a Block Conversion Channelizer

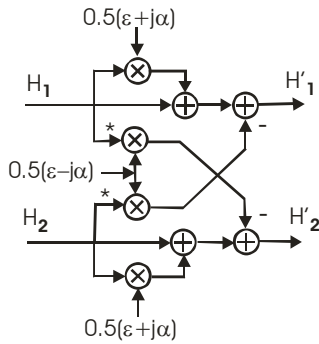

Figure 7. Model of Two-Channel Crosstalk due to I-Q Mismatch

The first order correction to remove the cross talk between the two channels subtracts the estimates of the crosstalk contamination from each of the corrupted signals. This relationship is shown in (5)

$$\begin{aligned} H_1 &\cong H_1' - 0.5 \cdot (\varepsilon + j\alpha) \cdot H_1' + 0.5 \cdot (\varepsilon - j\alpha) \cdot H_2'^* \\ H_2 &\cong H_2' - 0.5 \cdot (\varepsilon + j\alpha) \cdot H_2' + 0.5 \cdot (\varepsilon - j\alpha) \cdot H_1'^* \end{aligned} \quad (5)$$

To perform the desired cancellation, we require estimates of the mismatch terms α and ε . These terms can be obtained by forming the projection of one signal on the other normalized by the energy in each signal as is shown in (6). As in the single signal case, it is likely the crosstalk cancellation is performed with a gradient estimate of the mismatch terms as shown in (7).

Figure 8 presents the constellation diagram of a pair of frequency cross coupled signals. As can be seen, one is a 16-QAM signal and the other is an 8-PSK signal. The crosstalk is due to a 0.20 gain and 0.20 radian phase mismatch and we show the constellations during and after the

I-Q balancing process. Figure 9 presents the constellation diagrams of the same frequency coupled channels with one channel containing the 16-QAM signal set and the other, an empty band, containing no signal. Here we see only the effect of self interference in one channel and replica interference in the empty channel. Also shown is the constellation sets during and after the I-Q balancing operation. It is interesting to see the interference in the empty channel get driven to zero as a result of the I-Q balancing.

$$\begin{aligned} H_1' &= H_1 + 0.5 \cdot (\varepsilon + j\alpha) \cdot H_1 - 0.5 \cdot (\varepsilon - j\alpha) \cdot H_2^* \\ H_2' &= H_2 + 0.5 \cdot (\varepsilon + j\alpha) \cdot H_2 - 0.5 \cdot (\varepsilon - j\alpha) \cdot H_1^* \end{aligned} \quad (6)$$

$$\begin{aligned} E\{H_1' \cdot H_2'\} &= -0.5 \cdot (\varepsilon - j\alpha) \cdot E\{H_1 \cdot H_1^*\} \\ &\quad - 0.5 \cdot (\varepsilon - j\alpha) \cdot E\{H_2 \cdot H_2^*\} \end{aligned}$$

$$E\{H_1' \cdot H_2'\} \approx -0.5 \cdot (\varepsilon - j\alpha) \cdot [E\{H_1 \cdot H_1^*\} + E\{H_2 \cdot H_2^*\}]$$

$$(\varepsilon - j\alpha) \cong \frac{2 \cdot E\{H_1' \cdot H_2'\}}{E\{H_1 \cdot H_1^*\} + E\{H_2 \cdot H_2^*\}}$$

$$\begin{aligned} \hat{H}_1(n) &= H_1'(n) - \hat{\varepsilon}(n-1) \cdot [H_1'(n) - H_2'^*(n)] \\ &\quad - j\hat{\alpha}(n-1) \cdot [H_1'(n) + H_2'^*(n)] \\ \hat{H}_2(n) &= H_2'(n) - \hat{\varepsilon}(n-1) \cdot [H_2'(n) - H_1'^*(n)] \\ &\quad - j\hat{\alpha}(n-1) \cdot [H_2'(n) + H_1'^*(n)] \end{aligned} \quad (7)$$

$$\begin{aligned} \hat{\varepsilon}(n) &= \hat{\varepsilon}(n-1) - \mu \cdot \text{RL}[\hat{H}_1(n) \cdot \hat{H}_2(n)] \\ \hat{\alpha}(n) &= \hat{\alpha}(n-1) - \mu \cdot \text{IM}[\hat{H}_1(n) \cdot \hat{H}_2(n)] \end{aligned}$$

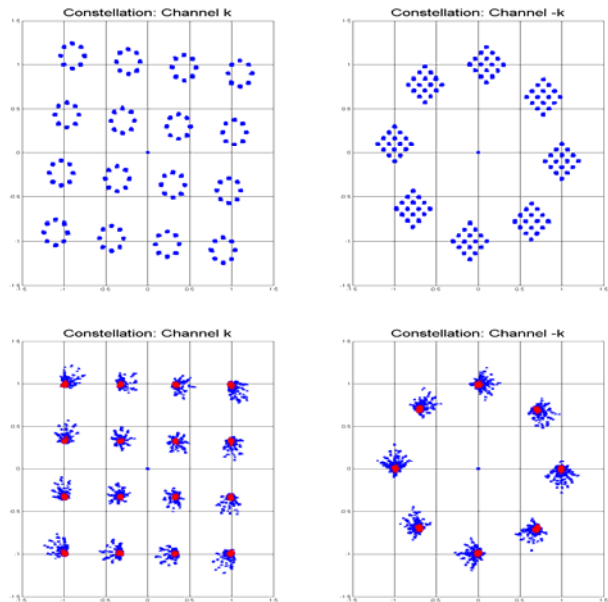

Figure 8. Frequency Cross Coupled Constellations Prior to and After Adaptive Cancellation

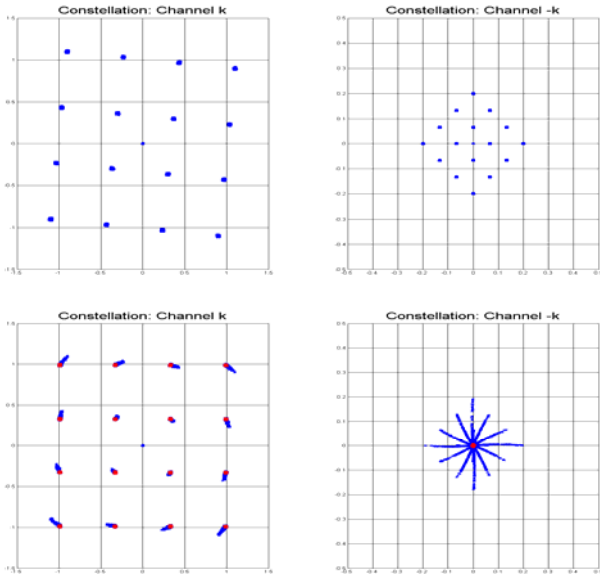

Figure 9. One Occupied and one Empty Coupled Constellations Prior to and After Adaptive Cancellation

4. Crosstalk between Frequency Offset Channels

In the previous section we examined the crosstalk between positive and negative frequency components of a down-converted frequency block. The center frequency of the spectrum being down converted may not coincide with the frequency of the quadrature oscillator performing the down conversion. This frequency offset may be due to Doppler induced frequency shift, standard tolerance spread of crystals at the transmitter and receiver, and oscillator frequency shifts due to crystal temperature and aging. In classical receivers, the detected frequency offset is detected and removed by a phase locked loop control of the analog controlled oscillator. Removing the frequency offset while the signal is still analog reduces the problem to a non problem. On the other hand, modern DSP based receivers remove the frequency offset as a digital complex heterodyne applied to the sampled data I-Q components. When the frequency offset is performed in the sampled data domain the crosstalk frequency components are also shifted so that the image frequency for frequency $+f_0$ is no longer $-f_0$ but rather at $-f_0+2\Delta f$. Figure 10 illustrates the frequency offset of the crosstalk spectral image. Here the amount of offset is greatly exaggerated for clarity of the illustration.

The crosstalk model shown in figure 7 has to be modified to reflect the effect of the $2\Delta f$ offset. The modified model is shown in figure 11. The observed complex terms H'_1 and H'_2 with offset crosstalk are related to the desired complex terms H_1 and H_2 by the relationship shown in (8).

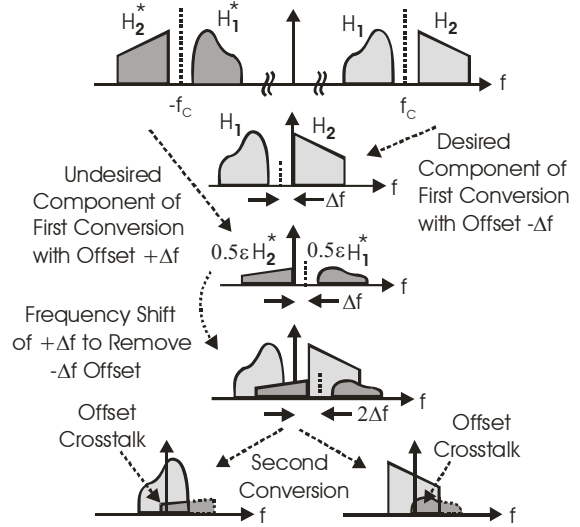

Figure 10. Spectral Crosstalk Between two Channels in a Block Conversion Channelizer with Initial Frequency Offset of Δf .

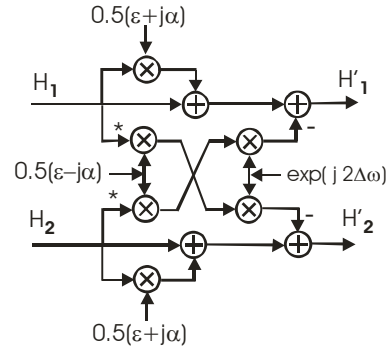

Figure 11. Model of Two-Channel Crosstalk due to I-Q Mismatch and Down Conversion Frequency Offset

$$\begin{aligned} H'_1 &= H_1 + 0.5 \cdot (\varepsilon + j\alpha) \cdot H_1 - 0.5 \cdot (\varepsilon - j\alpha) \cdot H_2^* \cdot e^{j2\Delta\omega t} \\ H'_2 &= H_2 + 0.5 \cdot (\varepsilon + j\alpha) \cdot H_2 - 0.5 \cdot (\varepsilon - j\alpha) \cdot H_1^* \cdot e^{j2\Delta\omega t} \end{aligned} \quad (8)$$

To estimate the mismatch terms α and ε we have to apply a compensating offset to the image component when we perform the projection process and then again for the canceling processes. The modification to (6) is shown in (9). As indicated earlier, it is likely the crosstalk cancellation is performed with a gradient estimate of the mismatch terms as shown in (10).

Figures 12 (a, b, c) present a sequence of constellation diagrams for a pair of frequency cross coupled signals. One channel is modulated with 16-QAM and the other with 8-PSK. The gain and phase imbalance of the analog I-Q down converter is 0.20 and 0.20 radians respectively.

$$\begin{aligned}
H_1' &= H_1 + 0.5 \cdot (\varepsilon + j\alpha) \cdot H_1 - 0.5 \cdot (\varepsilon - j\alpha) \cdot e^{j2\Delta\omega t} \cdot H_2^* \\
H_2' &= H_2 + 0.5 \cdot (\varepsilon + j\alpha) \cdot H_2 - 0.5 \cdot (\varepsilon - j\alpha) \cdot e^{j2\Delta\omega t} \cdot H_1^* \\
E\{H_1' \cdot H_2' \cdot e^{-j2\Delta\omega t}\} &= -0.5 \cdot (\varepsilon - j\alpha) \cdot E\{H_1 \cdot H_1^*\} \\
&\quad - 0.5 \cdot (\varepsilon - j\alpha) \cdot E\{H_2 \cdot H_2^*\} \\
&\approx -0.5 \cdot (\varepsilon - j\alpha) \cdot [E\{H_1' \cdot H_1'^*\} + E\{H_2' \cdot H_2'^*\}] \\
(\varepsilon - j\alpha) &\cong \frac{2 \cdot E\{H_1' \cdot H_2' \cdot e^{-j2\Delta\omega t}\}}{E\{H_1' \cdot H_1'^*\} + E\{H_2' \cdot H_2'^*\}}
\end{aligned} \tag{9}$$

$$\begin{aligned}
\hat{H}_1(n) &= H_1'(n) - \hat{\varepsilon}(n-1) \cdot [H_1'(n) - H_2'^*(n) \cdot e^{-2j\Delta\omega t}] \\
&\quad - j\hat{\alpha}(n-1) \cdot [H_1'(n) + H_2'(n) \cdot e^{-2j\Delta\omega t}] \\
\hat{H}_2(n) &= H_2'(n) - \hat{\varepsilon}(n-1) \cdot [H_2'(n) - H_1'^*(n) \cdot e^{-2j\Delta\omega t}] \\
&\quad - j\hat{\alpha}(n-1) \cdot [H_2'(n) + H_1'(n) \cdot e^{-2j\Delta\omega t}]
\end{aligned} \tag{10}$$

$$\begin{aligned}
\hat{\varepsilon}(n) &= \hat{\varepsilon}(n-1) - \mu \cdot \text{RL}[\hat{H}_1(n) \cdot \hat{H}_2(n) \cdot e^{-2j\Delta\omega t}] \\
\hat{\alpha}(n) &= \hat{\alpha}(n-1) - \mu \cdot \text{IM}[\hat{H}_1(n) \cdot \hat{H}_2(n) \cdot e^{-2j\Delta\omega t}]
\end{aligned}$$

The first pair of subplots presents the effect of cross coupling without a frequency offset. Here we see that located at each point in the constellation has been replaced by an image of the other channel's constellation and that the center of gravity of each constellation cluster has been rotated from its nominal position.

The second pair of subplots presents both the effect of cross coupling through the I-Q mismatch and the effect of a frequency offset removed by a digital down converter. Note that the down conversion successfully de-spins the channel data but not the cross coupled contribution from the image channel.

Finally, the third pair of constellations shows the trajectories of the cross coupled clusters and their center of gravity as the adaptive I-Q correction algorithm removes the effect of the I-Q imbalance in the presence of digitally corrected frequency offset.

5. Conclusions

We have examined the effect of gain and phase imbalances between the analog mixers of a quadrature down converter in a receiver. When the down converted channel is brought to base band without a frequency offset the imbalances cause coupling between the real and imaginary (I and Q) components of the signal. We illustrated that the coupling can be suppressed by an adaptive canceller that uses residual correlation between I and Q to remove the cross coupled signal component.

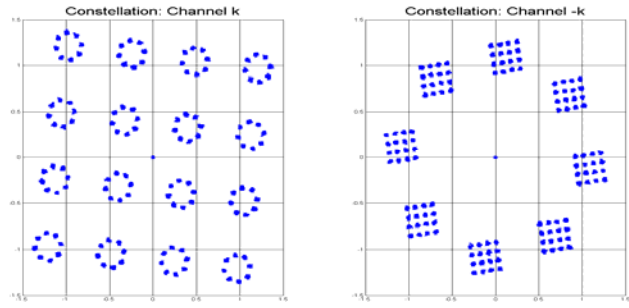

Figure 12a. Cross Coupled Constellations without Frequency Offset

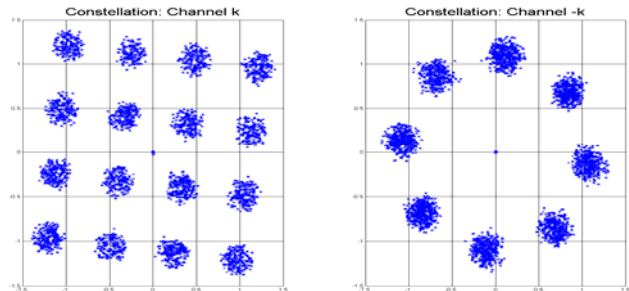

Figure 12b. Cross Coupled Constellations with a Corrected Frequency Offset

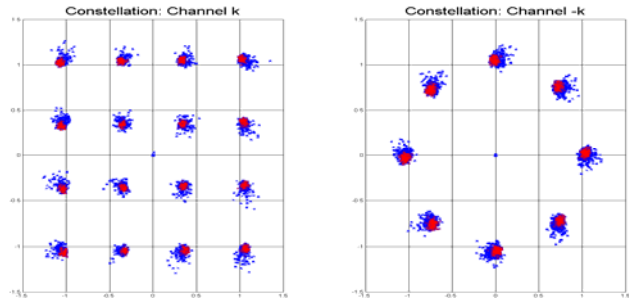

Figure 12c. Cross Coupled Constellations after Adaptive Cancellation of Rotating Cross Coupled Terms

We then showed that when the down converted signal is part of a block down conversion, the positive and negative frequency components representing two channels in the spectrum are cross coupled through the I-Q imbalance. The cross coupling is now seen to be between two sets of complex signals, accessible from the output of subsequent second conversions of the two image channels from frequency f_k and $-f_k$. In a fashion similar to the single channel cancellation algorithm, the components common to each channel can be removed from each channel by a pair of cross coupled cancellers.

We finally demonstrated the additional consideration that had to be addressed when the result of the first down conversion contains a frequency offset. If this offset is removed by controlling the frequency of the analog quadrature oscillator there is no problem. If the offset is not removed and the frequency offset I-Q pair is digitized with the intent of having subsequent digital signal processing perform the frequency translation and acquisition, then we have a minor problem. As we indicated, the problem is that while offsetting the carrier to the desired center frequency, we are also offsetting the image frequency which we need to retrieve when rejecting the spectral terms related to the I-Q gain and phase imbalance. We presented the modification to the I-Q cross canceller algorithm that permitted the offset image terms to be translated back to the frequency required to support the cross canceling process. The local digital oscillator (or DDS) must not only supply signal to the digital down converter, but must also supply the same signal to the I-Q balancer.

As a practical matter, when ever we design receivers containing balanced analog quadrature mixers we always include digital I-Q balancing algorithms in the signal processing path. In the same vein, we also include DC cancellers to remove the DC injected in the signal path by various parasitic couplings and imbalances found in the analog components in the signal flow path.

6. Acknowledgements

While there is much current activity in I-Q balancing techniques for OFDM systems, the work reported here

predates this current interest. In fact this work has been developed over a 20 year period in support of design activity conducted for pioneering groups with which we have worked on the development of innovative DSP based receivers. Often a question posed by a bright person is the seed planted in receptive minds that lead to interesting and novel solutions. One of our authors, Itzhak Gurrantz has sown many of these seeds.

7. References

- [1]. fred harris, "On Measuring the Gain and Phase Unbalance and DC Offsets of Quadrature A-to-D Converters with an Adaptive Canceling Filter", 21st Annual Asilomar Conference on Signals, Systems, and Computers, Pacific Grove, CA. 2-4 November 1987.
- [2]. M. Valkama, M. Renfors, V. Koivunen, "Advanced Methods for I/Q Imbalance Compensation in communication Receivers", IEEE Trans, Signal Processing, vol. 49, Oct. 2001, pp 2335-2344.
- [3]. fred harris, "On Probing Gain, Phase, and Time Delay Imbalance in Transmitters and Receivers", Internal Report, Entropic Corporation. San Diego, CA, May 2002.
- [4]. MATLAB I/Q Imbalance in Communications Blockset